

Impact of M₂-Hss Tool Pin Profile in Fsw Welded Joints On Mechanical Properties Of Aa7075-T6 Aluminium Alloy

Venugopal S^a, G. Mahendran^b, E.Ravikumar^c,M. Sivashanmugam^d

^a Asst. Professor, Department of Mechanical Engineering, CK College of Engineering & Technology, Cuddalore 607 003, India.

^bPrincipal, IFET College of Engineering, Villupuram 605 108, India.

^c Asst. Professor. Department of Mechanical Engineering, Alpha College of Engineering. Thirumazhisai, Thiruvallur District, Chennai 600 124, India.

^dAssociate Professor. Department of Mechanical & Production Engineering. Sathyabama University, Chennai 600 119, India.

Abstract

Friction stir, “welding is a solid state joining process and is widely being considered for aluminium alloys. The main advantage of FSW is the material that is being welded undergoes only localized changes. The welding parameter and tool pin profile play a major role in deciding the weld quality. In this work an effort has been made to analyze microstructure of aluminium AA 7075-T6 alloy. Three different tool profiles (Taper Threaded, cylindrical and square) have been used to construct the joints in particular rotational speed. Tensile, Impact, micro hardness of mechanical properties of the joints have been evaluated and the formation of FSP zone has been analyzed microscopically. From the investigation it is found that the threaded cylindrical profile produces highly (defined) Strength in welds.

Keywords: AA 7075-T6 aluminium alloy; Friction stir welding; Tool pin profile; FSP zone; Tensile, Impact evaluation.

I. Introduction

AA7075-T6 is the most widely used material for the construction of leading and trailing edges, Helicopter rotor blades and navy bulk head joiner panels. It has unique combination of properties such as good weld ability, light weight and high strength properties. The normally used welding process for these materials is TIG, MIG, the electron beam welding process [1]. AA7075-T6 is a heat treatable alloy so for welding the rotational speed is considered for effective welding and the parameters are designed accordingly [2].

So, in considering the need of friction stir welding in vast application, the material is welded using friction application, the material is welded using friction stir welding process. Friction stir Welding (FSW) process is an emerging joining Technology than can eliminate usual defects that occur in the weld area and refine the microstructures, thereby improving strength and ductility, increasing resistance to corrosion and fatigue and enhance the properties of the weld.

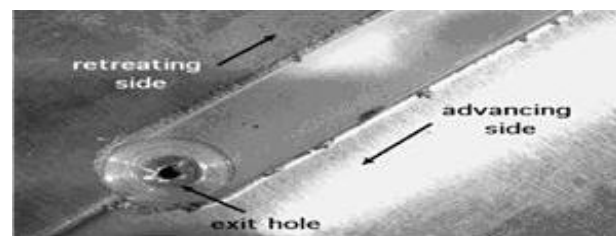
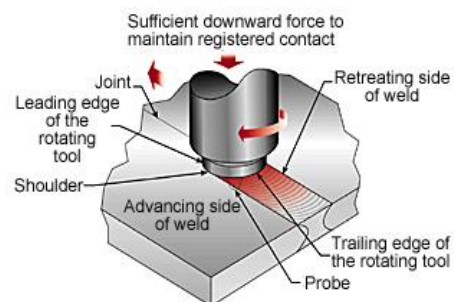

(a)

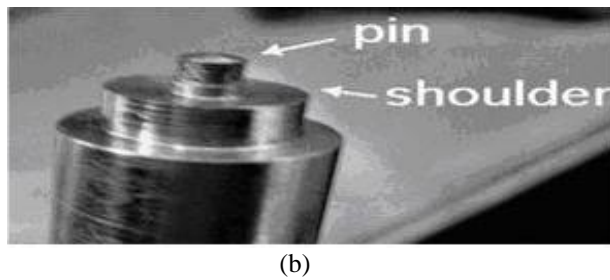

Fig. 2- (a) An FSW weld between aluminum sheets. (b) An actual tool, with a threaded-pin

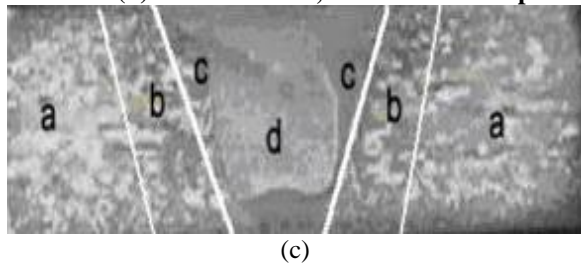

Fig. 3-Different regions of FSW joint: (a) unaffected base metal; (b) heat affected zone (HAZ); (c) thermo-mechanically affected zone (TMAZ); (d) friction stir processed (FSP) zone.

The FSW is usually carried out in solid an is a continuous hot shear autogenous weld involving a non consumable rotating probe of harder material than the material that abutting faces of the joint. The relative motion between the tool and base metals creates frictional heat by forming a plasticized zone near and around the tool. The tool shoulder also helps in containing the plasticized material in the weld region. As the tool traverses forward the plasticized material follows to form solid phase joint. The major advantage of FSW is that it follows local thermo mechanical metal working process without influencing properties of surrounding areas as observed in other welding process [3].

FSW joints consist of four different rejoin, they are (a)untouched base material (b)heat affected zone(HAZ) (c)Thermo mechanically heat affected zone(TMAZ) (d) Friction stir processing zone(FSP). These zones are normally affected by the rotating probe of the tool when it traverses the joint area. So probe to find relationship between tool profile and

II. EXPERIMENTAL PROCEDURE:

The base metal used for the is Al-Zn alloy in which the manganese increases the corrosion resistance, ductility and toughness. The aluminum plates are cut into required size of (200mmX75mm) by power saw cutting and grinding. A single pass weld was made in the butt joint area. Butt joints have been made. The tool that was used is a non-consumable tool of made of high speed steel. Three different tools as shown in fig 2a&2b are made. Using each tool a single joint is made. The machine

used for welding was specially made. The welding speed of 800rpm with table feed of 65mm/min was taken in consideration [4]. The load applied was 1 ton to achieve better weld without defects. The tool hardness was set between 50 to 70 HRC. Tool profile shapes and dimensions are shown in fig. 2a & 2b.

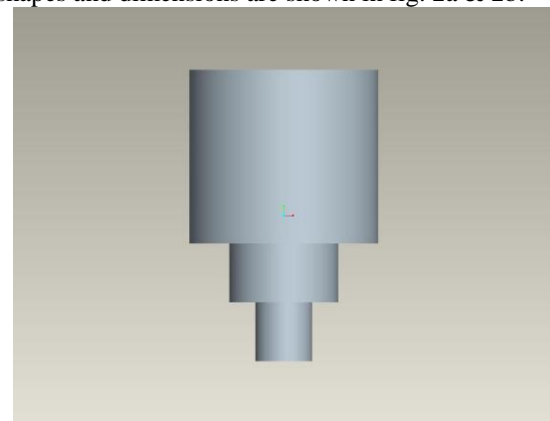

Fig 4 .Square pin profile

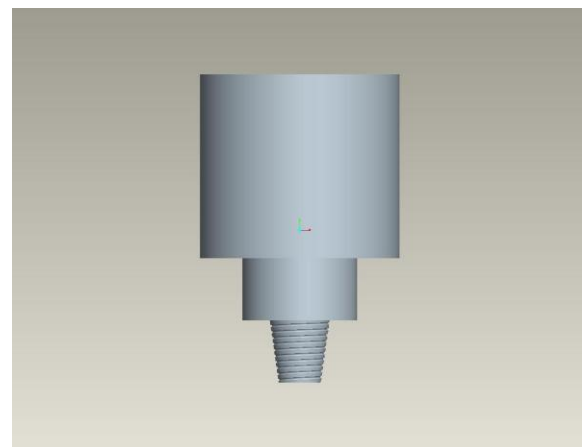

Fig 5.Taper threaded pin profile



Fig 6. FSW Weldments

III. TEST

The welded joints are sliced through power hacksaw and machined to the required dimension to prepare tensile test specimens are shown in fig. 1b.

American society for testing of materials (ASTME8-4) guidelines is followed for preparing the test specimens. Tensile test are carried out in the universal testing machine with reference to ASME-sec ix. Initially the was loaded 100KN, and then it is loaded gradually at the rate of 1.5KN/mm as per specification. The specimen fails after necking and load versus displacement has been recorded. The 0.2% offset yield strength; ultimate tensile strength and percentage of elongation have been evaluated. Micro hardness test has been employed (Vickers hardness)[5] for measuring micro hardness across the joint with 0.2kg load.

Similarly the welded joints are sliced through power hacksaw and machined to required dimension to prepare specimen for tensile and impact test as shown in fig. American society for testing of materials guidelines is followed for preparing the test specimens. Tensile and impact tests are conducted in the respective machines. The values are recorded. The specimens for me.[8]

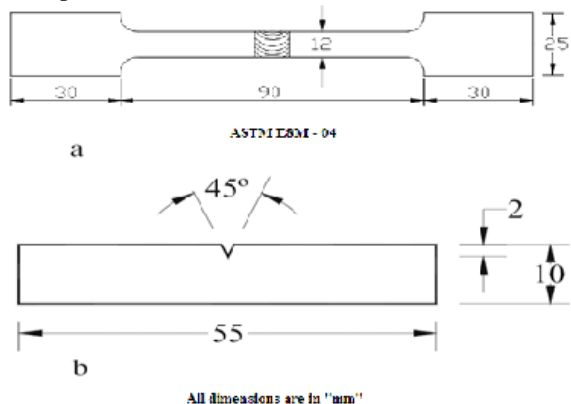

Schematic diagram of a tensile and b impact specimen

Fig.7.Schematic diagram of (a) tensile and (b) Impact specimen

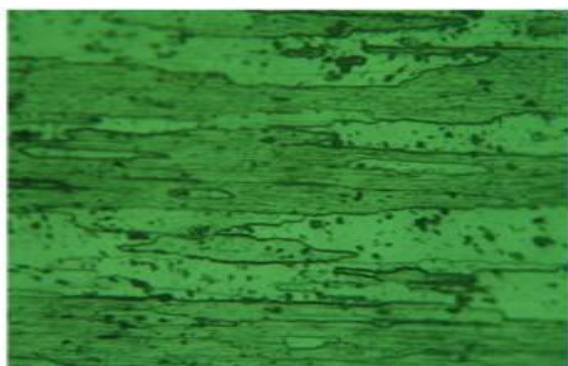

Fig.8 Base metal AA7075 microstructure investigation

(Table- 1)

Al	Zn	Mg	Mn	Cr	Cu	Fe	Si	Ti	Ni
87.1 to 91.4	5.1 to 6.1	2.1 to 2.8	0.2 to 0.3	0.18 to 0.28	1.4 to 2.0	0.18	0.4	≤0.029	≤0.029

Table.1. Base metal AA7075 chemical composition

IV. Results and Discussion

4.1. Tensile strength value

(Table- 2)

SL.NO	SAMPLE ID	UTS VALUE (N-m)	% ELONGATION
1	W _S T ₁₁	197.8	11
2	W _S T ₁₂	191.35	11.5
3	W _S T ₁₃	331.36	11.5
4	W _S T ₂₁	321.79	12
5	W _S T ₂₂	229.5	11
6	W _S T ₂₃	264.8	11

4.2. Impact value

(Table- 3)

SL.NO	SAMPLE ID	AMBIENT TEMP (30 ⁰ C)	IMPACT VALUE(J)
1	W _S T ₁₁	30 ⁰ C	4
2	W _S T ₁₂	30 ⁰ C	4
3	W _S T ₁₃	30 ⁰ C	5
4	W _S T ₂₁	30 ⁰ C	4
5	W _S T ₂₂	30 ⁰ C	4
6	W _S T ₂₃	30 ⁰ C	6

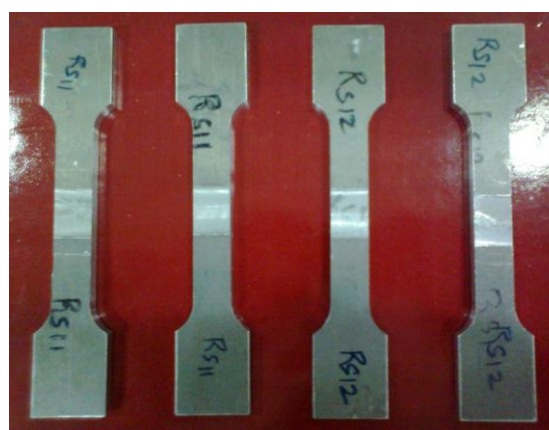

Fig. 7. Tensile test specimens of Friction Stir Welded joints of A7075 before testing.



Figure .8 Tensile test specimens of Friction Stir Welded joints of AA7075 after.

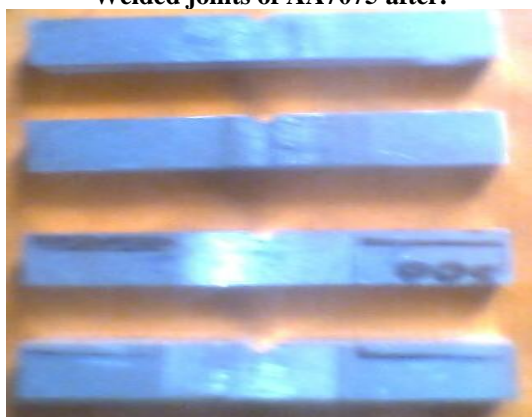

Figure. 9 Impact Specimens before Testing for Friction Stir Welded joints



Figure.10 Impact Specimen after Testing for Friction Stir Welded joints

4.3. Micro Hardness

The micro hardness values for three different zones namely FSP, HAZ, Base metal is found.

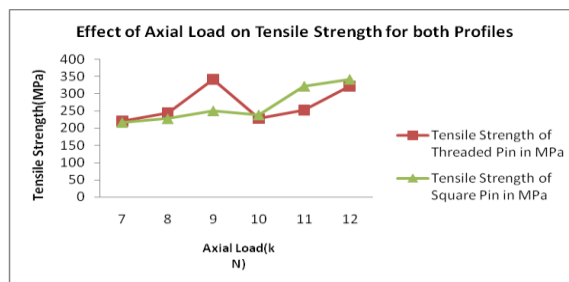

(a)

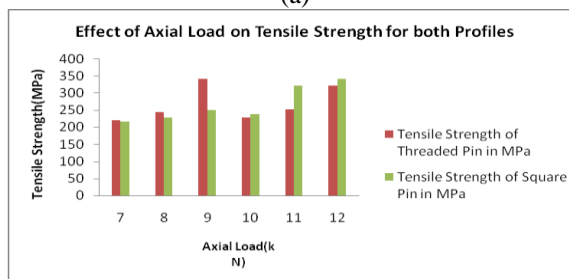

(b)

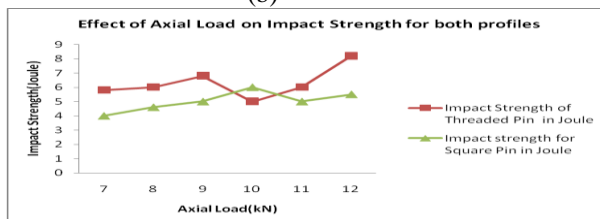

(c)

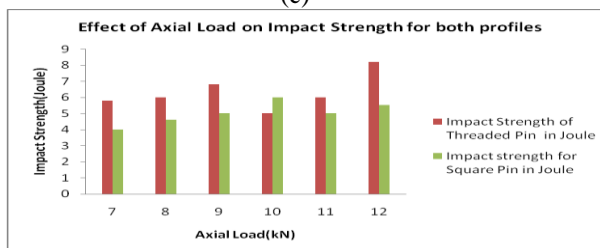

(d)

Fig.11 (a) and (b) Effect of axial load on Tensile Strength for both profile; (c) and (d) Effect of axial load for Impact Strength for both Profile.[7]

The micro hardness test was performed using micro hardness machine for the square pin and taper threaded pin values are tabulated

Square Pin Profile micro hardness value tabulated:-

Table 5

Weld	142	141	142
HAZ	142	141	142

Taper Threaded Pin Profile micro hardness value tabulated:-

Table 6

T1-TAPER THREAD, 8KN, 75MM/MIN

Table 7

4.4. Micro structure

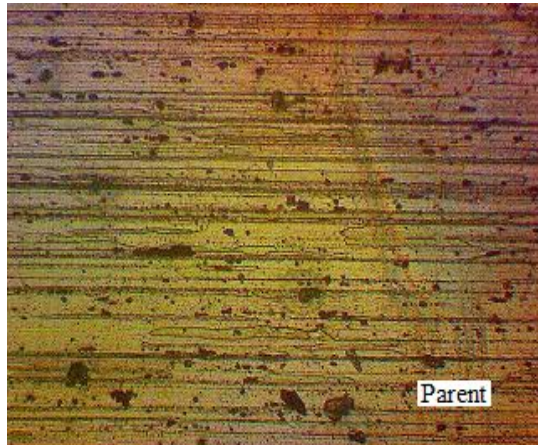

Figure.12 Micro structure of Parent metal

Shows the parent metal microstructures which seem to be wrought aluminum alloy. The phases present are the Mg₂Si and fine particles of Cu-al₂. The matrix also shows the undissolved Al₆ (Fe, Mn) inter metallics. The rolling bands along the direction of the rolling of the plate.

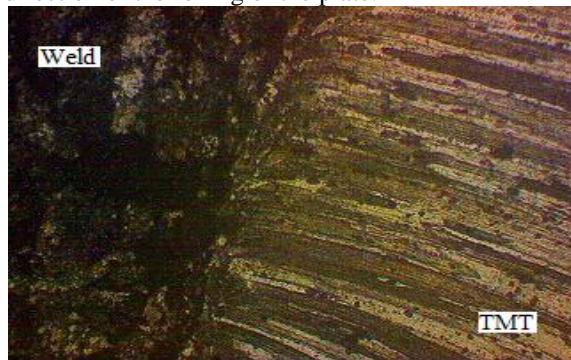

Figure.13 Micro structure of TMT and weld zone

Shows the TMT zone where the direction of the base metal has changed due to the friction stir force and heat. The heat made the dissolved phase reappear as bigger particles.[6]

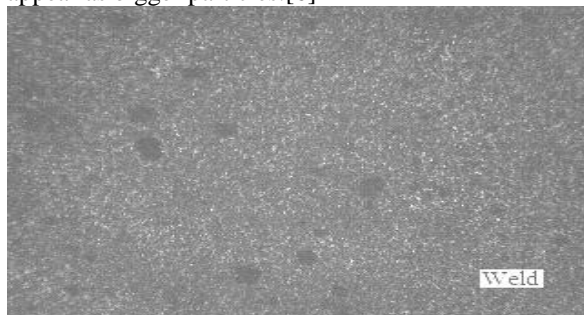

Figure.14 Micro structure of weld zone

Shows the interface location of the TMT and weld zone. The particles in the weld zone are finer due to the fragmentation and growth.

SAMPLE	PARAMETERS	BASE METAL	HAZ	WELD
SAMPLE 1 Taper Threaded Pin	RST11- 1600 RPM, 8KN	182	172	165
SAMPLE2 Taper Threaded Pin	RST21- 8KN, 75mm/min, 1500RPM	182	168	163
SAMPLE 3 Square Pin	RST21, 7 KN, 75mm/min, 1500RPM	182	155	152
SAMPLE 4 Square Pin	RST22, 9KN, 75mm/min, 1500RPM	182	161	162

The complete cross-section of the FSW zone with the parent metal on both the sides. The FSW zone shows the presence of unfilled tunnel cavity with the presence of some black particles.

V. CONCLUSION

Considerable grain refinement has been achieved due to friction stir welding and the plastic flow. Due to retracting and advanced force the grains size are formed dynamic recrystallized zone

The Taper threaded cylindrical pin profile has been best suited at 800 rpm for better tensile strength, HAZ 172,168 and in weld zone 165,163 weld results and higher quality for this alloy.

The results can be applied for replacement of rivets in aircraft, rocket propulsion and automobile sectors where this alloy is used.

REFERENCES

- [1] Elangovan, V Balasubramanian *Influence of tool pin profile and welding speed on the formation of friction stir processing zone in AA2219 alloy*
- [2] K. Elangovan, V Balasubramanian *Influence of tool pin profile and rotational speed of the tool by (journal)*
- [3] yutaka A sato, Yusuke Sugiura, park, kokwa, Ikeda *Post welded formability of friction stir welded aluminium alloy 5052*
- [4] A. Scialpi, L.A.C De Filippies, P. Caviliere *Influence of shoulder geometry on microstructure and mechanical properties of friction stir welded 6082 aluminium alloy*

- [5] Thomas, W.M.; et al.: "*friction stir welding*", U.S.Patent 5,460,317.
- [6] Dawes, C.J.; and Thomas, W.M.: "*Friction Stir Process Welds Aluminium Alloys*", *Welding Journal*, pp.41 – 45, March 1996.
- [7] Midling, O.T.; "*Material Flow Behaviour & Microstructural Integrity of Friction Stir Butt Weldments*", Fourth International Conference. In *Aluminium alloys*, pp. 451 – 458, September 1994.
- [8] Mark van den Bergh from DWA Aluminium Composites, Inc.